

# SDSS-V: Robots to Sky

Juna A. Kollmeier

Director

[jak@cita.utoronto.ca](mailto:jak@cita.utoronto.ca)

[@sdssurveys](#)



Thank you SDSS I-IV  
and all of our partners!

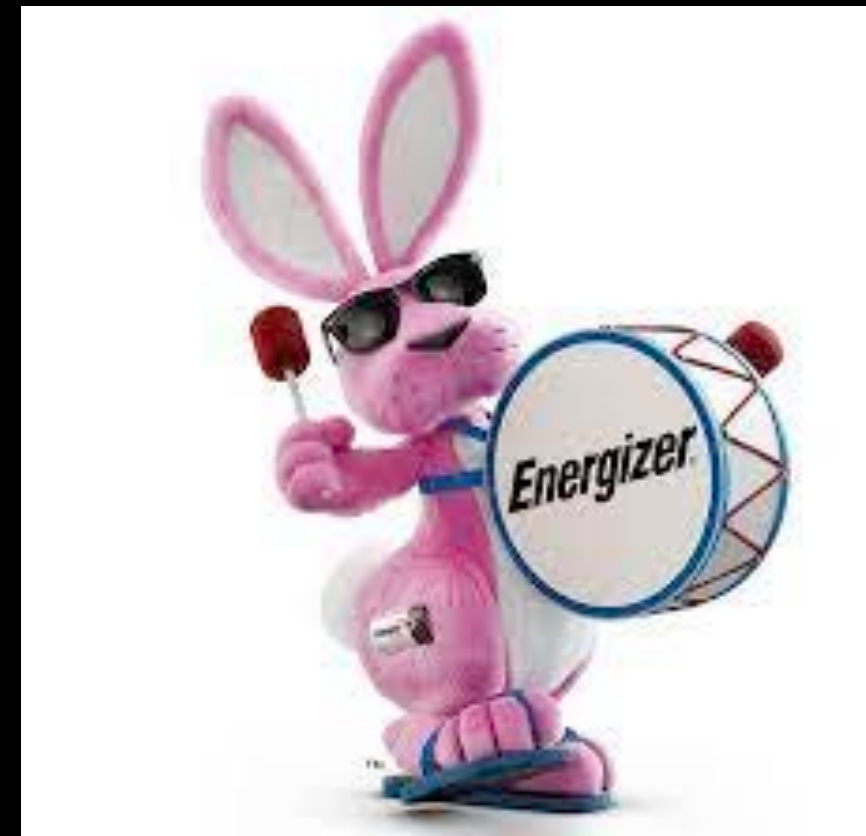
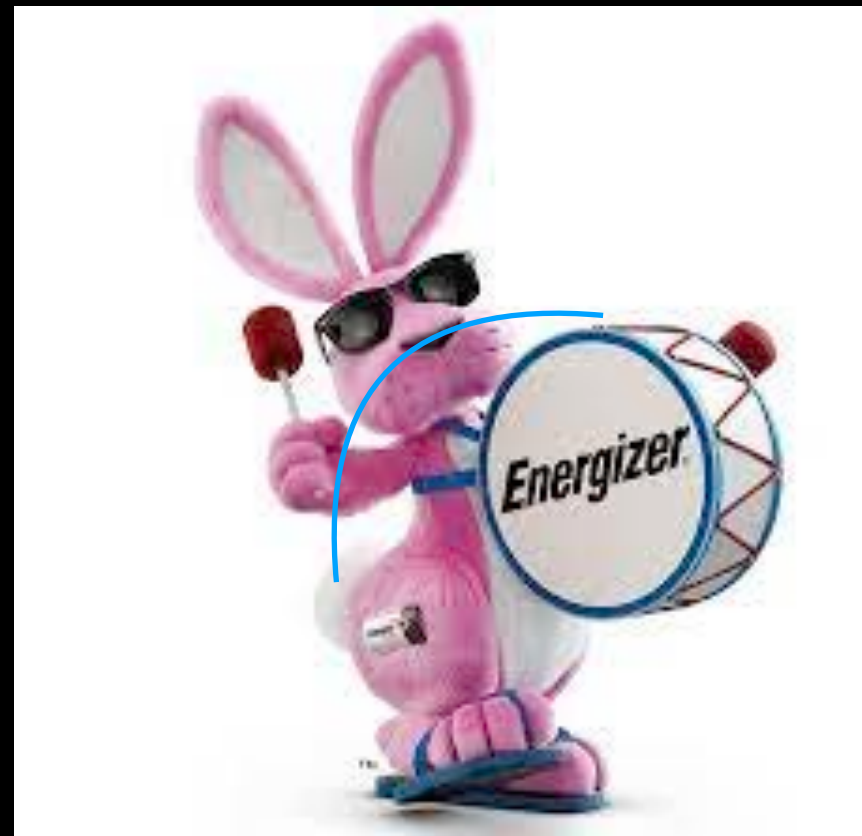



# THE MILKY WAY MAPPER

FORMATION OF THE  
MW AND ITS STARS

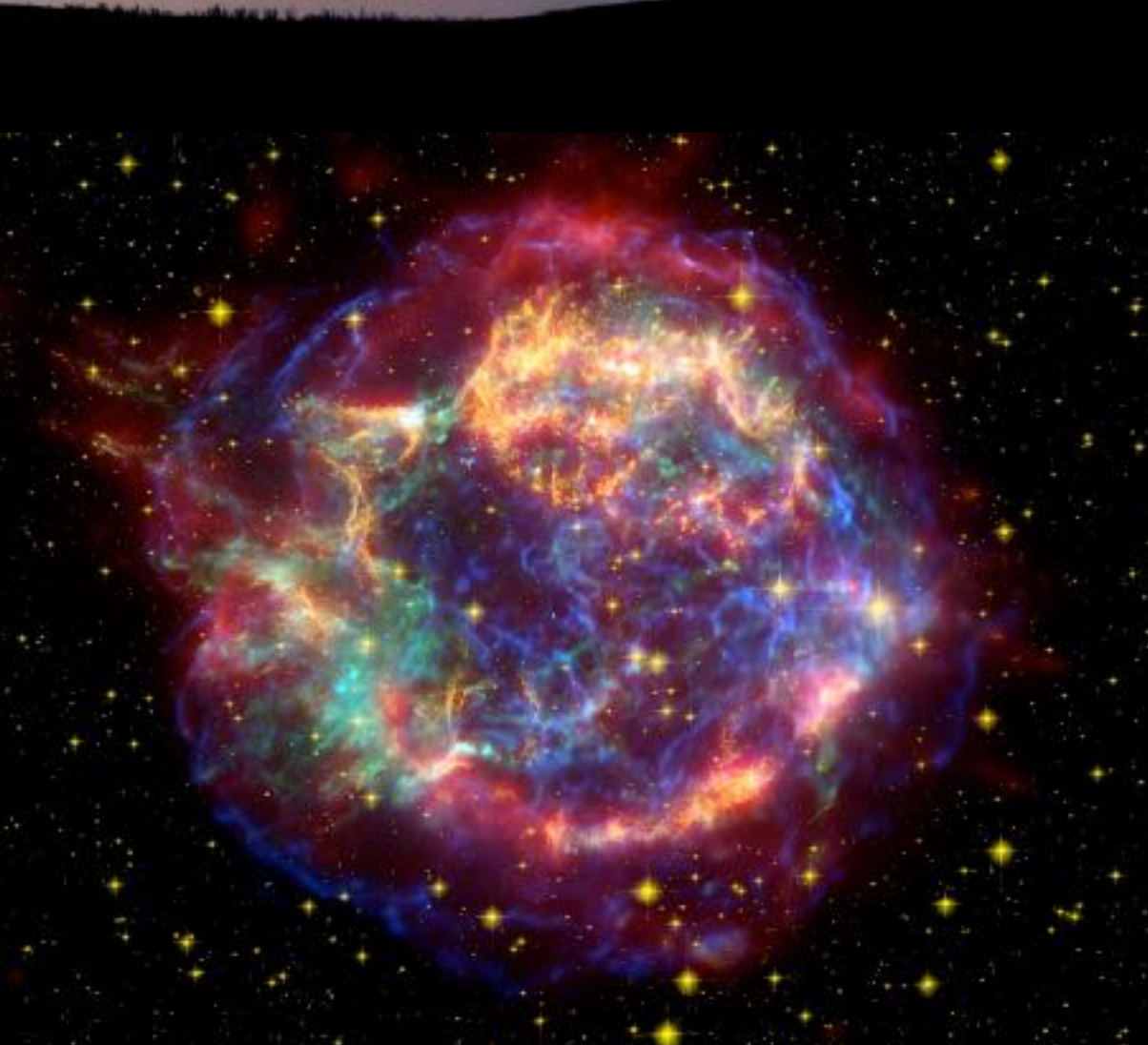

# THE LOCAL VOLUME MAPPER

UNDERSTANDING HOW  
GALAXIES REGULATE  
THEMSELVES

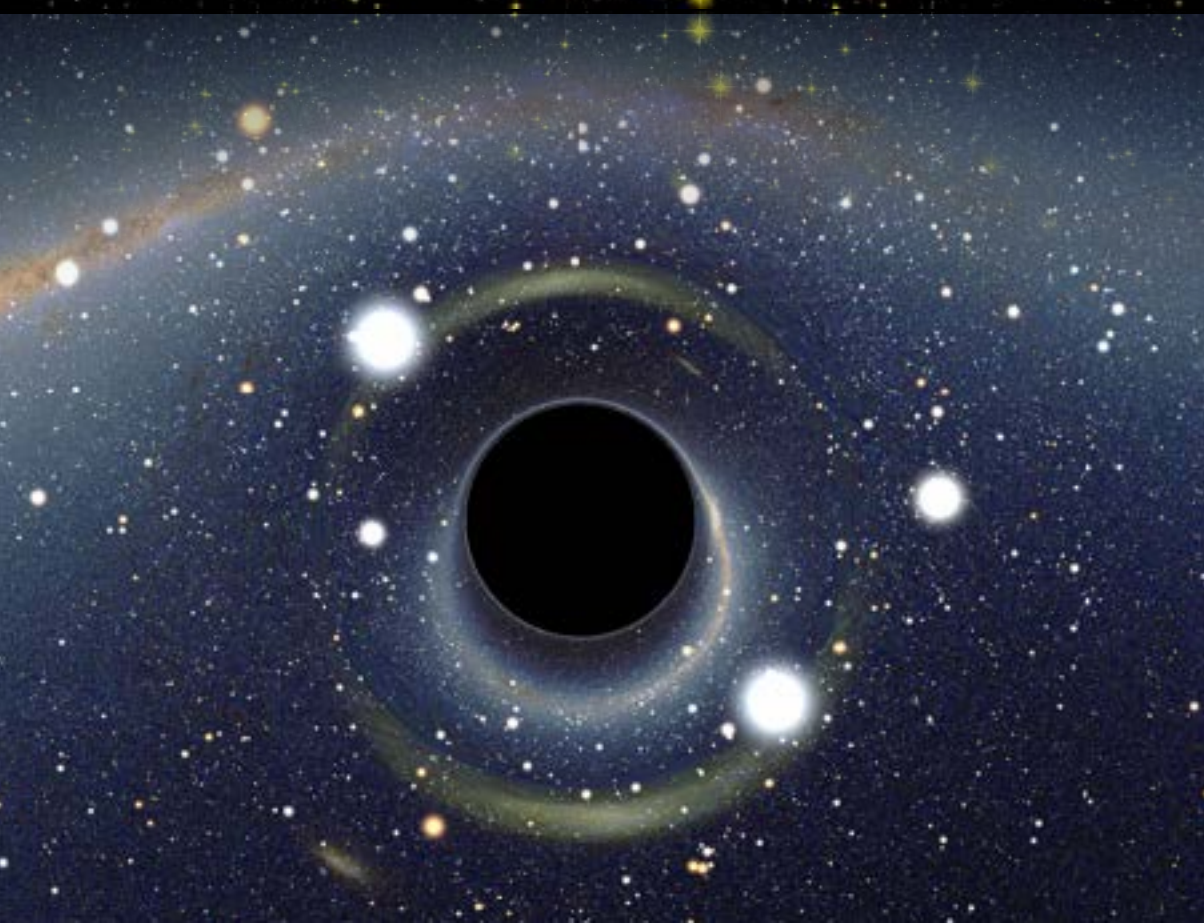

# THE BLACK HOLE MAPPER

HOW BLACK HOLES BIG  
AND SMALL GROW

# HOW IT STARTED

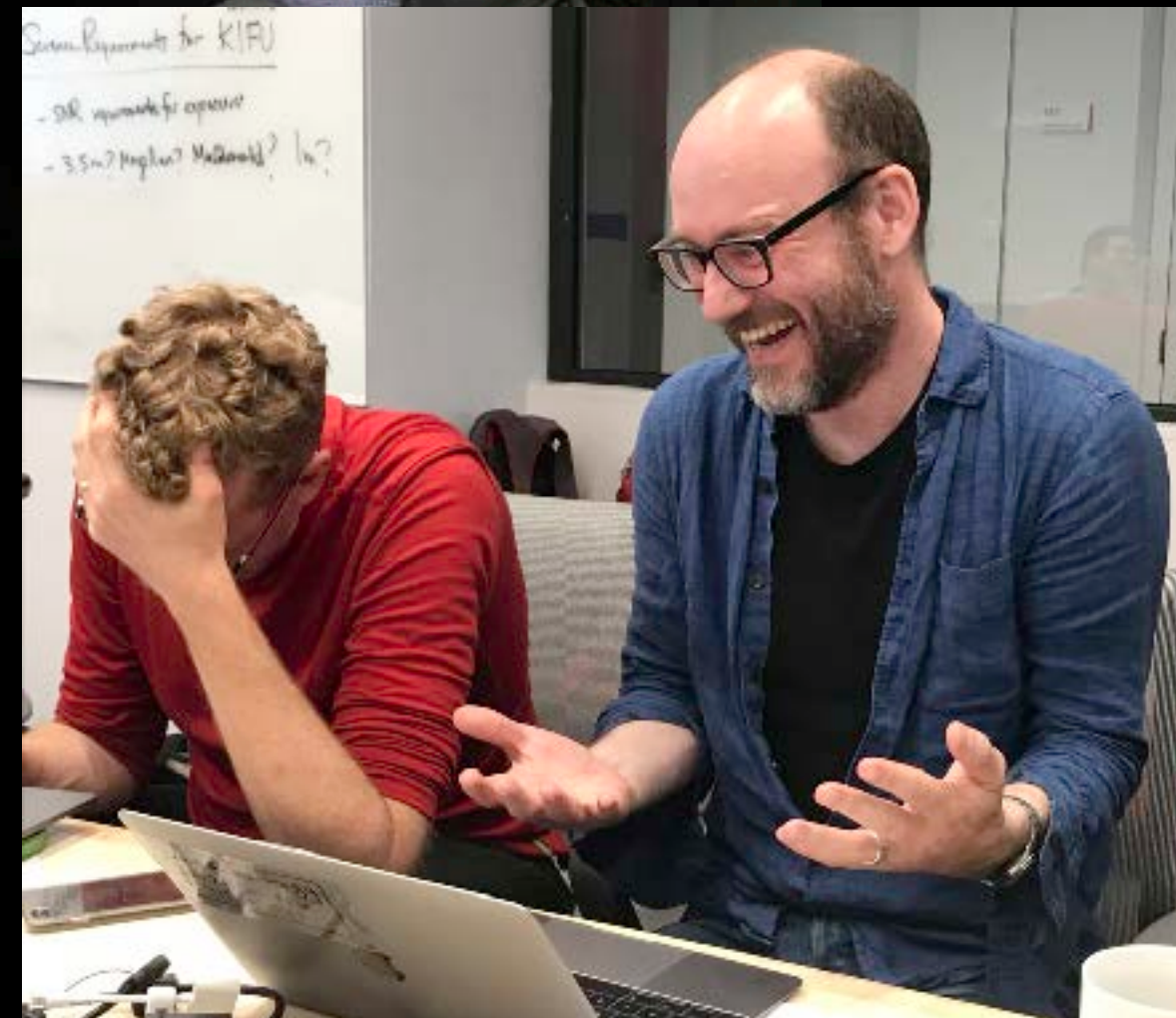

# HOW IT'S GOING

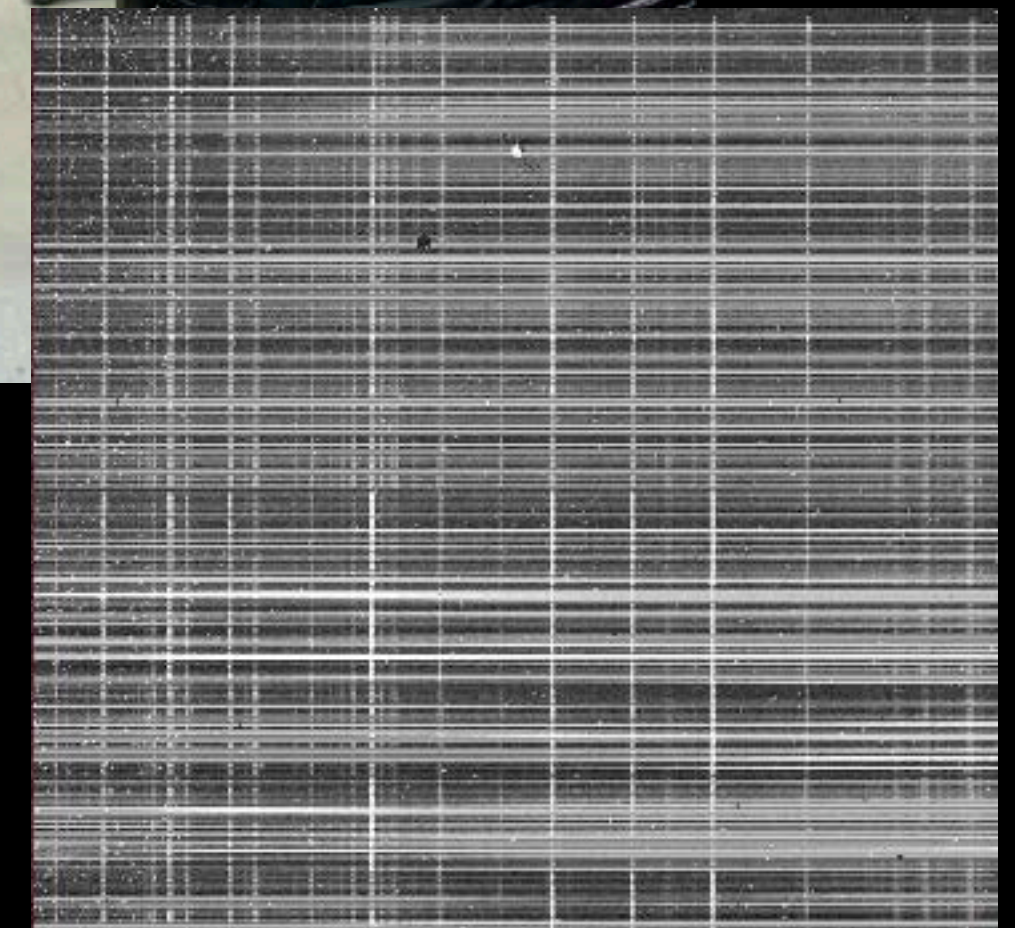

# HOW IT STARTED



# HOW IT'S GOING



# HOW IT STARTED

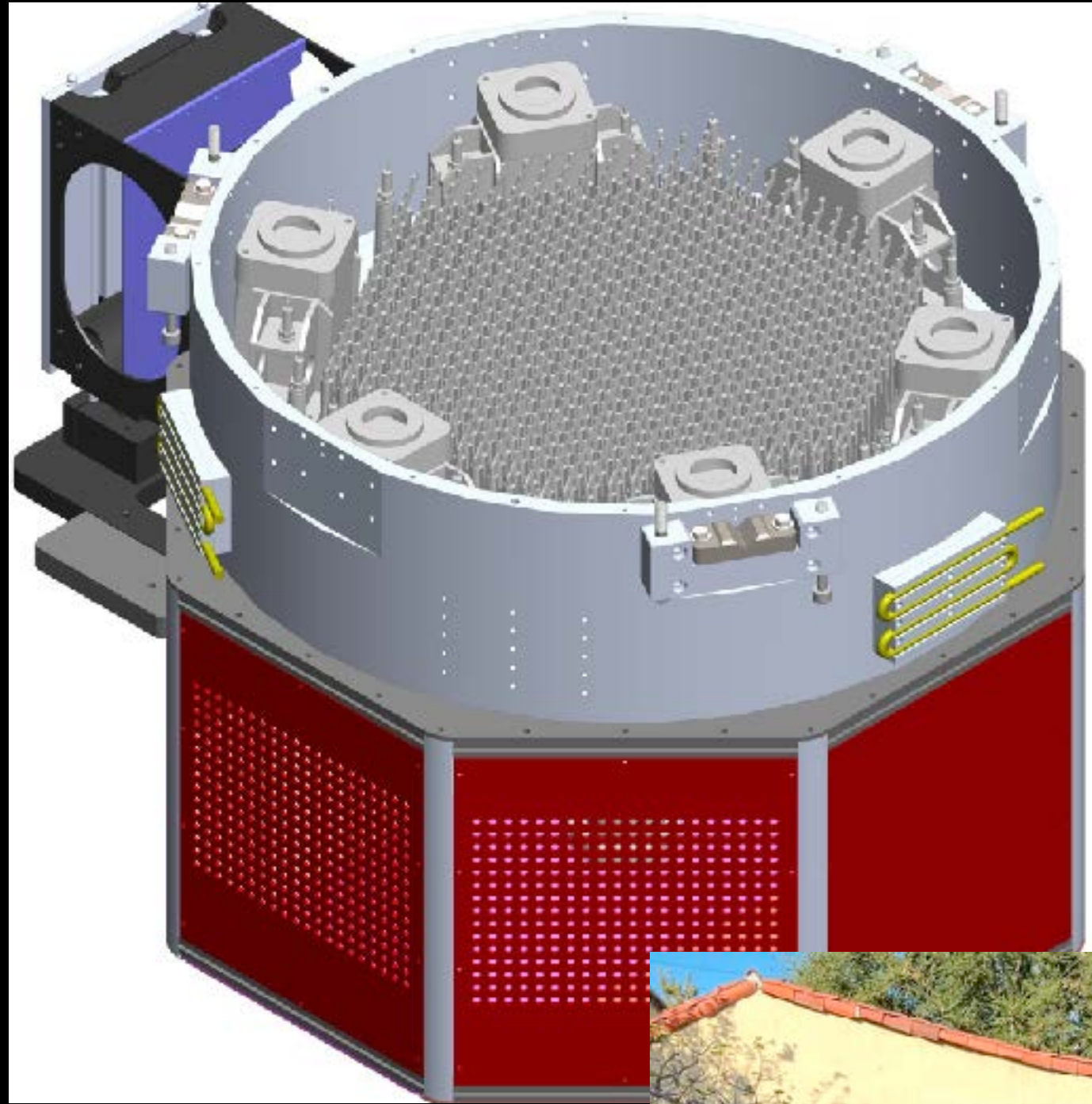

# HOW IT'S GOING

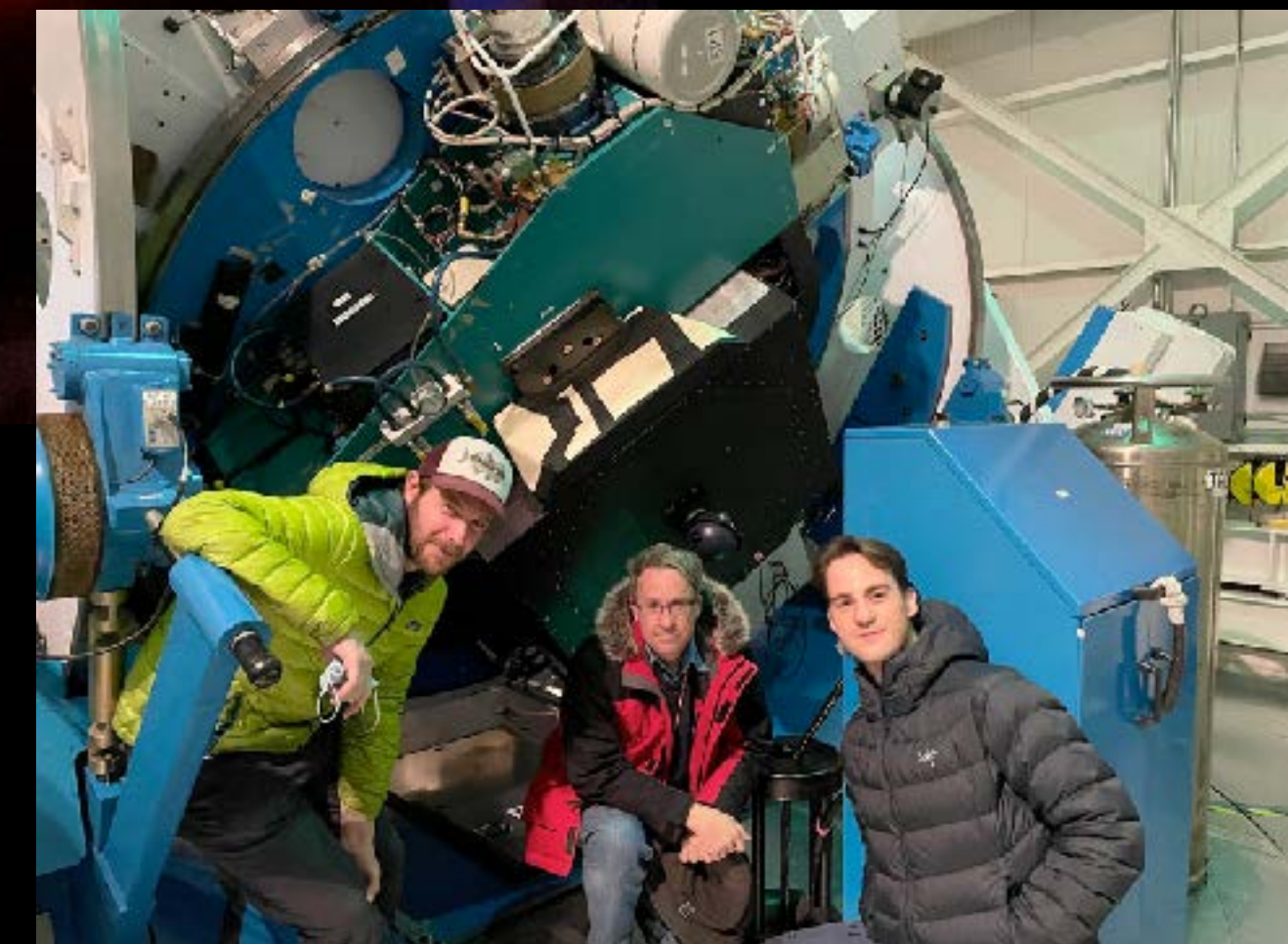
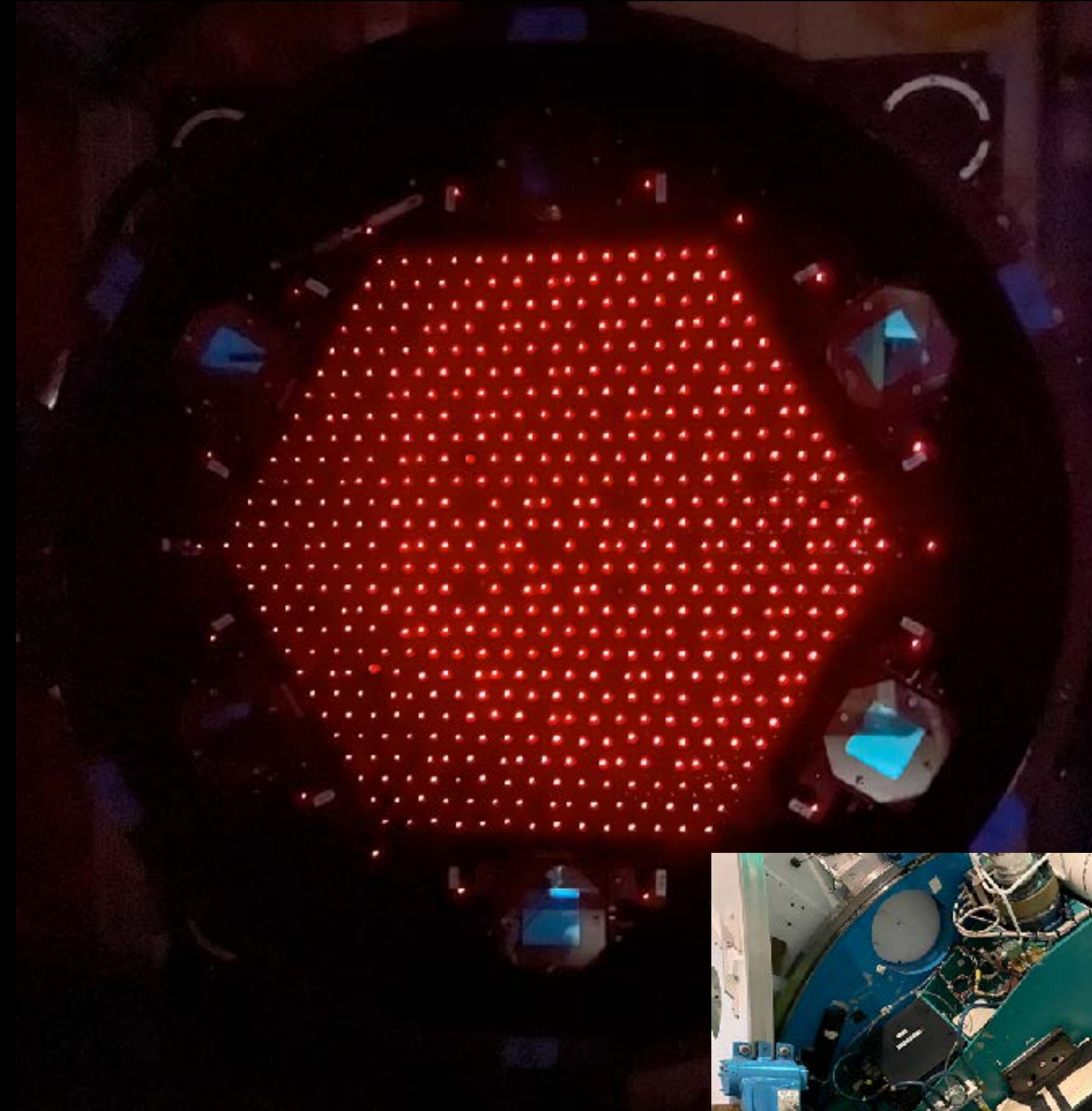

# HOW IT STARTED

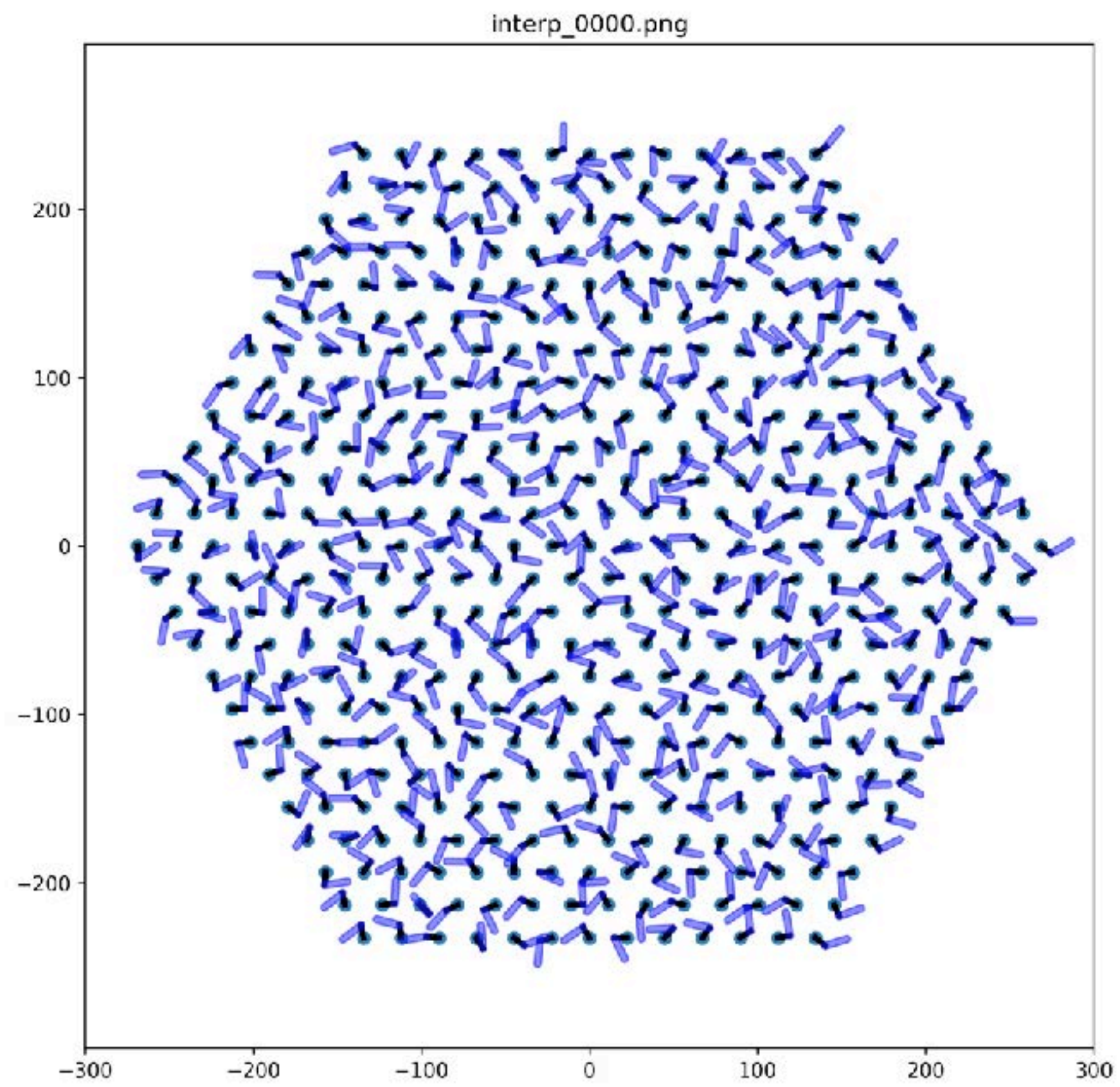

# HOW IT'S GOING

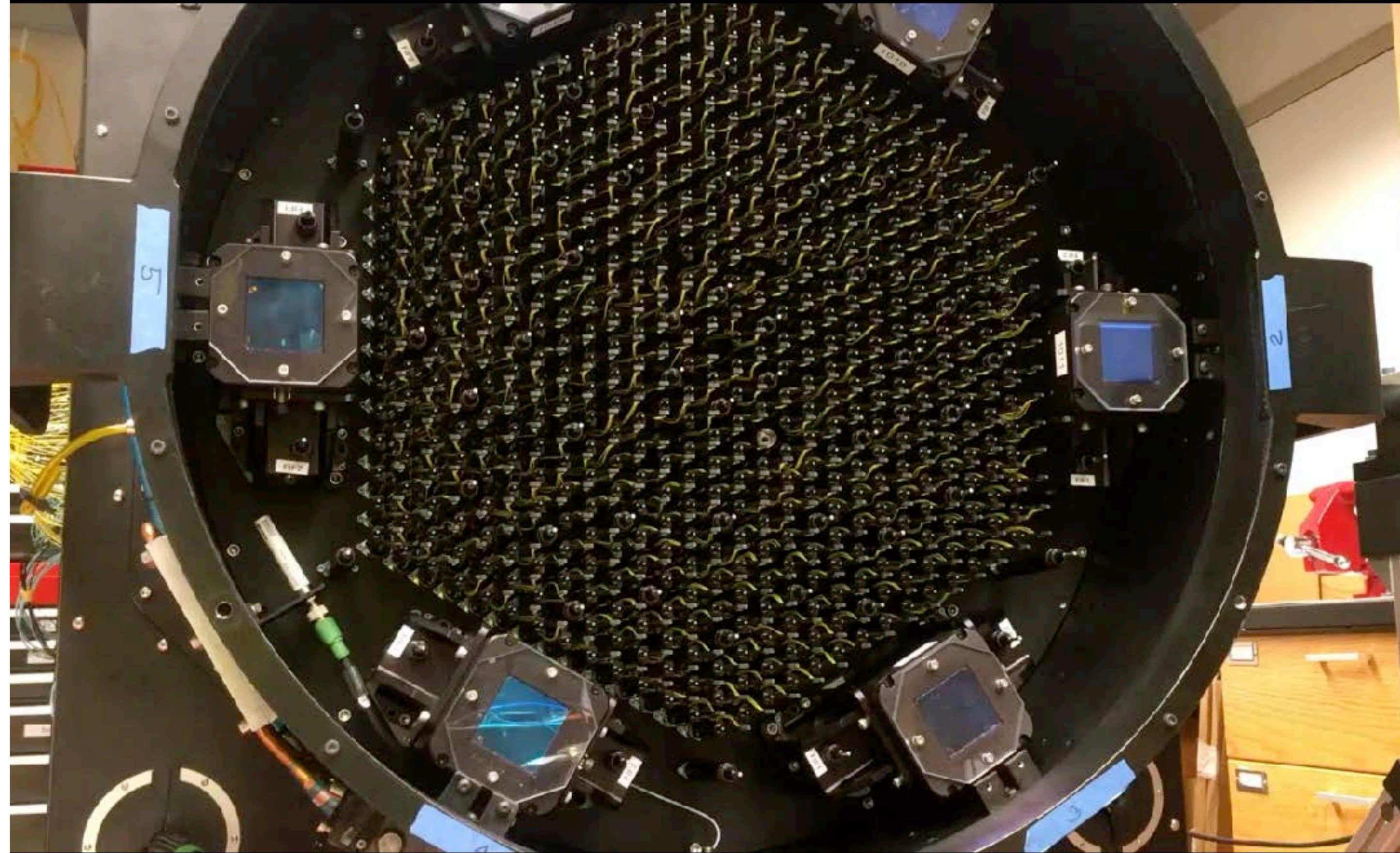

HOW IT'S GOING

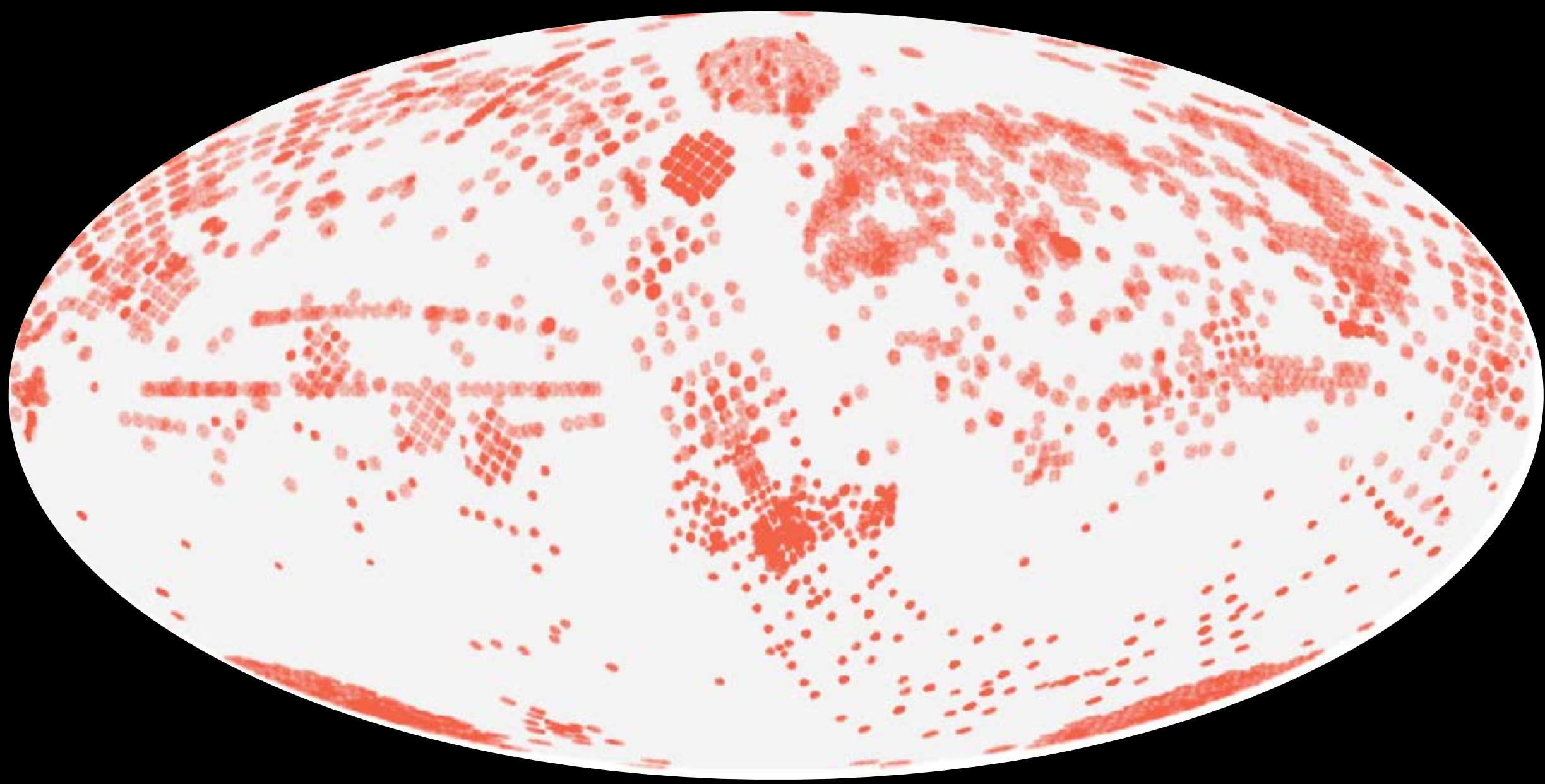

WHERE IT'S HEADED

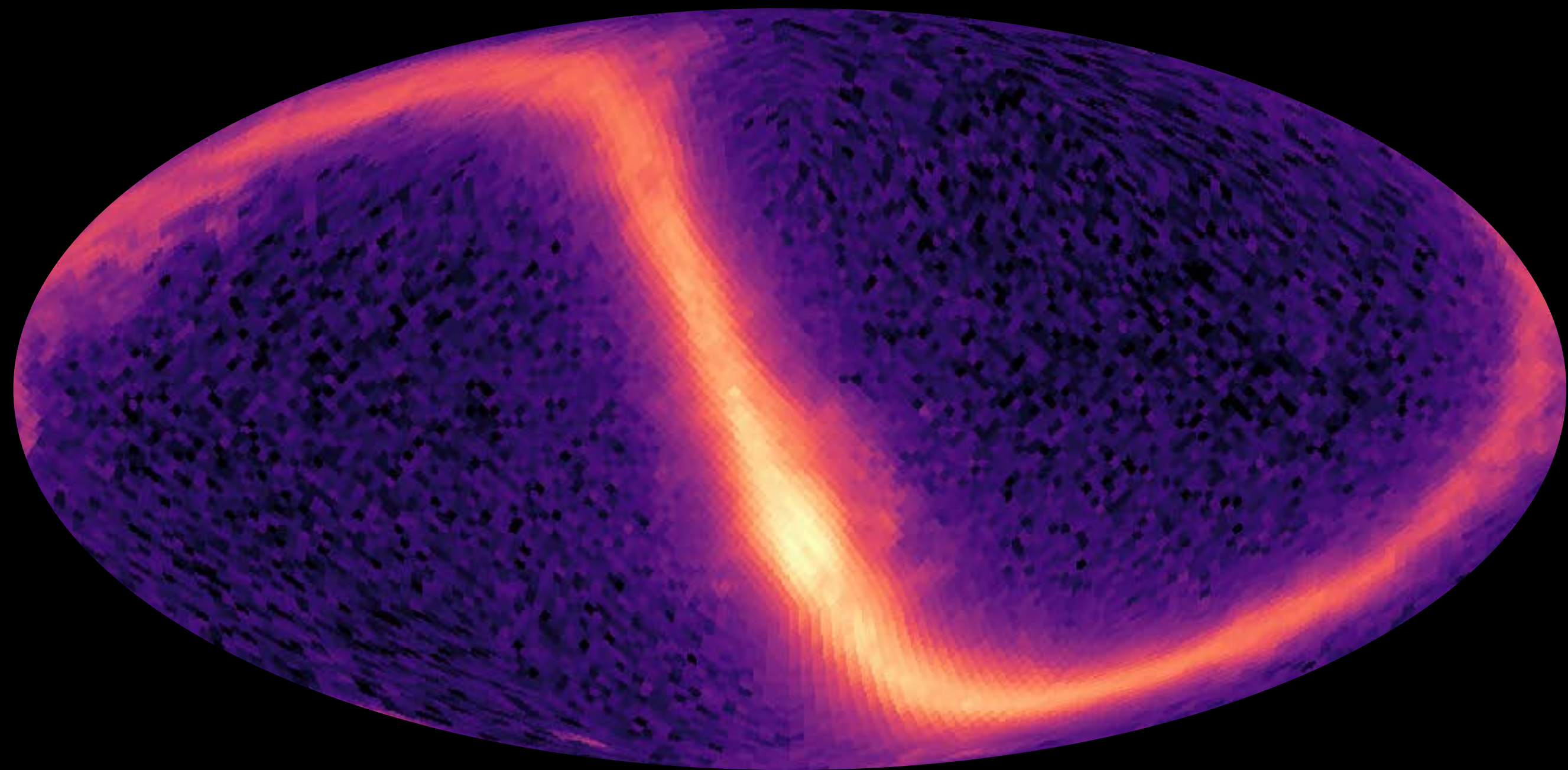





**JOIN US.**

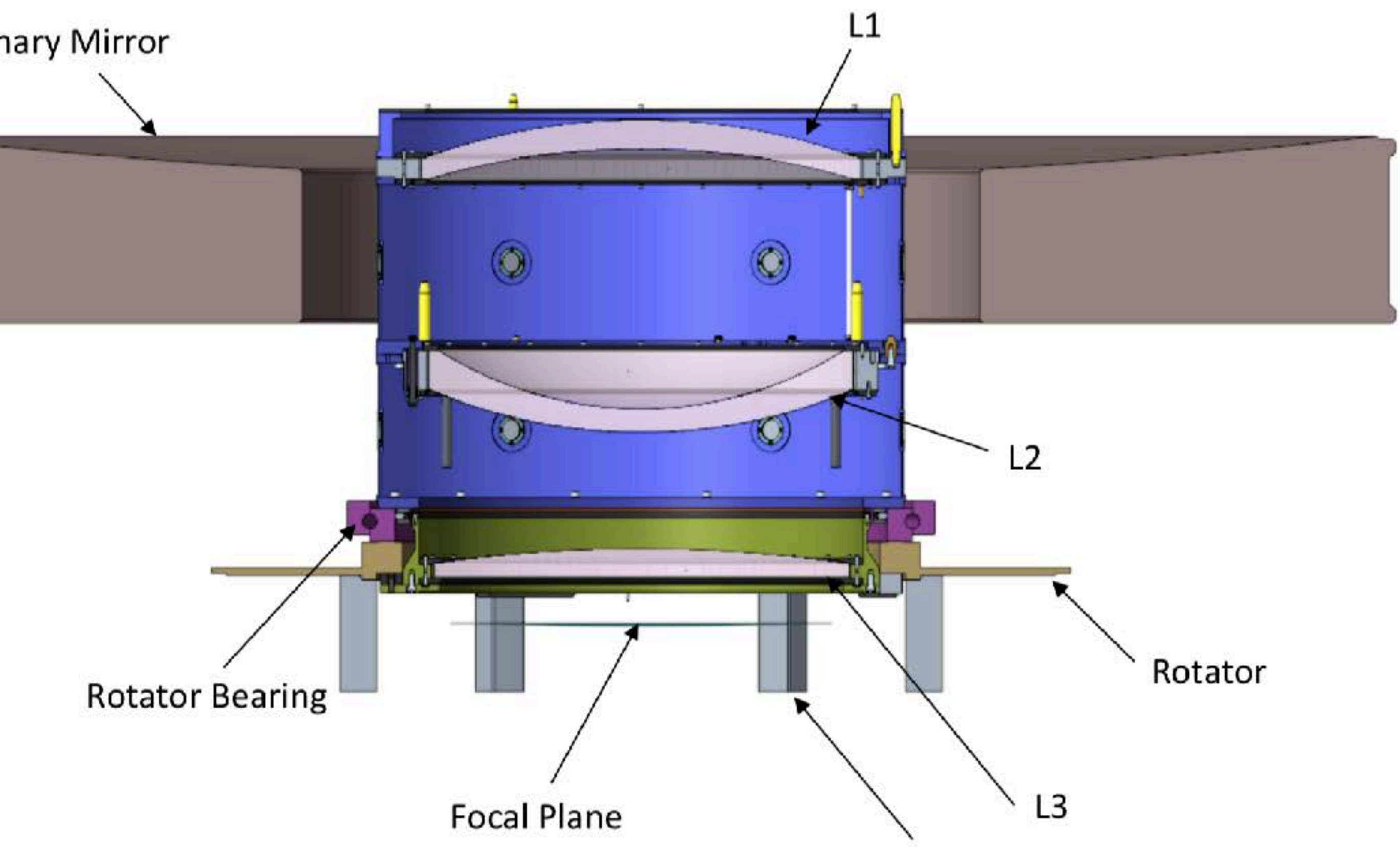

(6X) Over-Center Clamp;  
note we use only three  
for mounting L3

